

Technical Validation

Better Together: Optimizing Application Performance with Riverbed SD-WAN Acceleration

Validating the Benefits Derived from the Riverbed SteelHead Portfolio

By Alex Arcilla, Senior Validation Analyst

December 2022

This Enterprise Strategy Group Technical Validation was commissioned by Riverbed and is distributed under license from TechTarget, Inc.

Introduction

This Technical Validation from TechTarget’s Enterprise Strategy Group (ESG) documents our evaluation of the Riverbed SD-WAN Acceleration solution. We reviewed testing that demonstrated how this solution can help organizations to optimize application performance on SD-WAN connections.

Background

Organizations undergoing digital transformation initiatives ultimately want to become more competitive. According to research from Enterprise Strategy Group (ESG), 52% of respondents to a recent research survey stated that they wanted to become more operationally efficient (see Figure 1).¹

Figure 1. Top 5 Objectives for Digital Transformation Initiatives



Source: Enterprise Strategy Group, a division of TechTarget, Inc.

One approach that organizations use to become operationally efficient is to employ software-defined wide area networking (SD-WAN). Respondents to another ESG research survey cited that the top benefits of using SD-WAN included achieving greater operational efficiencies (31%) and increasing network bandwidth (34%), as SD-WAN optimizes the use of available network transport services to connect users to applications, such as wireless, broadband, and MPLS. Yet, that same survey revealed that only 19% of respondents indicated improved user/employee experience as a top benefit from using SD-WAN.²

To further increase operational efficiency, it is critical for end users to have the best possible experience, which typically translates into high application performance. With higher application performance, employee productivity increases, as they can fulfill business needs and make critical decisions without unnecessary delay. For example, radiology medical practices typically download and analyze large files necessary for diagnosis. By accelerating transfers of large data files, productivity increases, subsequently decreasing costly medical salary expense, shortening patient wait times, and enabling doctors to see more patients per day.

¹ Source: ESG Research Report, [2022 Technology Spending Intentions Survey](#), November 2021.

² Source: ESG Research Report, [Network Modernization in Highly Distributed Environments](#), November 2021.

While SD-WAN offers measures to guarantee some level of application performance by increasing network efficiency (e.g., using alternative forms of network transport at any given time), organizations cannot take chances with their most critical business applications and rely on the quality and reliability of the underlying transport alone.

Riverbed SD-WAN Acceleration

To help organizations optimize application performance, Riverbed has designed a solution that combines the network efficiency provided by Riverbed’s SD-WAN solution, SteelConnect EX (an OEM of Versa Networks), with the application acceleration capabilities of the Riverbed SteelHead portfolio. The Riverbed solution can optimize application performance over SD-WAN links, thus removing the causes of end user dissatisfaction, such as poor application response time and stalled applications.

SteelConnect EX has been designed to provide agile and cost-effective WAN connectivity using Versa SD-WAN technology. By creating a virtual overlay on the organization’s transport network, organizations can dynamically create secure virtual connections between any location, independent of the underlying transport (e.g., 4G/5G, broadband, MPLS). Depending on an organization’s policies, network traffic can be sent over any combination of underlying transport as network conditions dictate.

With SteelHead Acceleration, organizations can accelerate both cloud application and data transfer performance via:

- *Transport streamlining* - improves data transfer performance and throughput of TCP-based networks by reducing or eliminating the impact of high latency, limited TCP window size, jitter, packet loss, and out-of-order packet delivery. (This can apply to other transport protocols such as high-speed TCP, MX-TCP, and TCP-Westwood.)
- *Data streamlining* - reduces bandwidth utilization and network roundtrips through the combination of advanced scalable data referencing (data deduplication) and compression of all network data, including secure support for SSL/TLS/HTTPS based protocols.
- *Application streamlining* - decreases the number of round-trip interactions encountered in any on-premises, SaaS, or IaaS-hosted application over the SD-WAN to mitigate the effects of high latency.

Riverbed leverages the SteelConnect EX multitenant software platform to integrate SteelHead as a physical or virtual application via service chaining, as illustrated in Figure 2.

Figure 2. Deployment Options for SteelConnect EX with SteelHead Acceleration

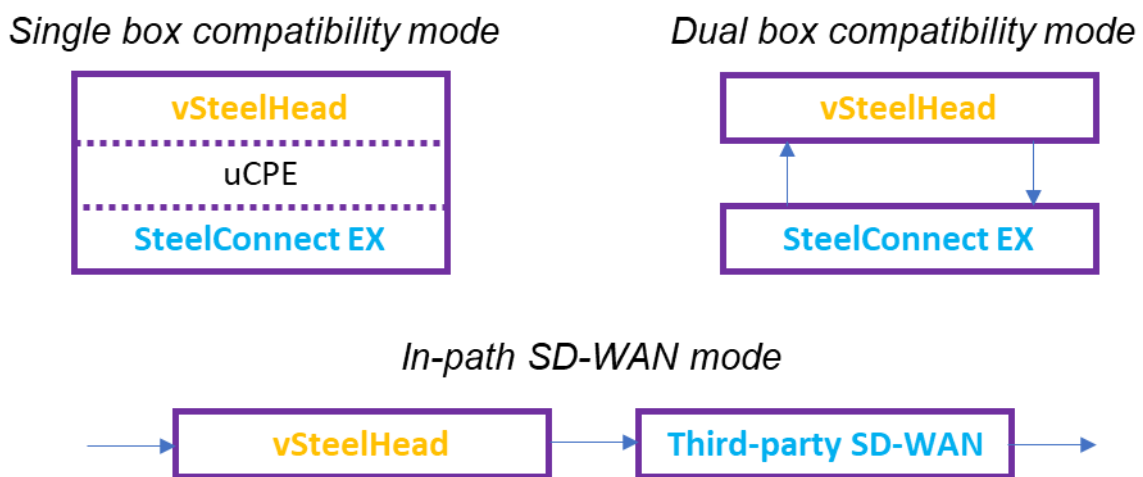

Source: Enterprise Strategy Group, a division of TechTarget, Inc.



Enterprise Strategy Group Technical Validation

Enterprise Strategy Group (ESG) evaluated results of tests conducted to compare the performance achieved using Riverbed SteelConnect EX alone versus the combination of Riverbed SteelConnect EX with SteelHead Acceleration. We evaluated the differences in performance achieved in two use cases: branch-to-cloud and branch-to-branch.

Branch-to-cloud Use Case

To evaluate the increase in performance that can be achieved with Riverbed Acceleration (or Acceleration) in SD-WAN connections between branch offices and the public cloud, Enterprise Strategy Group (ESG) evaluated performance test results showing the acceleration achieved when downloading a 700 MB image from a web server hosted in the Amazon Web Services (AWS) Cloud.

Enterprise Strategy Group (ESG) Testing

ESG used a testbed that combined an SD-WAN link connecting a client server in a virtual branch office staged in the Riverbed R&D Lab located in Oakland, CA (or VLAB) with a web server hosted in AWS. The single-box compatibility mode (illustrated in Figure 2) was employed on the client side using the SteelConnect EX3080 appliance with universal customer premises equipment (uCPE) and virtual SteelHead VCX60. On the AWS side, the dual compatibility mode terminated the SD-WAN link in the AWS US-West-2 availability zone (AZ). The web server was hosted on an Ubuntu virtual machine (VM). The round trip time (RTT) between the AWS AZ and VLAB was 26 milliseconds. (Please refer to the *Appendix* for the testbed diagram.)

To gain perspective into why Acceleration can help to optimize performance, ESG first examined the variability of traffic observed during a cold (or first) pass of a 50% compressible file—or 2x Lempel-Ziv³ (LZ) compression—through the SteelHead appliance, as shown in Figure 3. After enabling Acceleration on the SteelHead appliance on the client side, ESG observed that the maximum WAN throughput was half of the LAN throughput. (We did note that variability in throughput as the file was transferred was due to transmitting over the public internet.)

³ Lempel-Ziv compression is a lossless compression technique that reduces bits by identifying and eliminating statistical redundancy in the data, ensuring that no information is lost during file transfer.

Figure 3. Variability in Traffic Throughput from Branch to Public Cloud

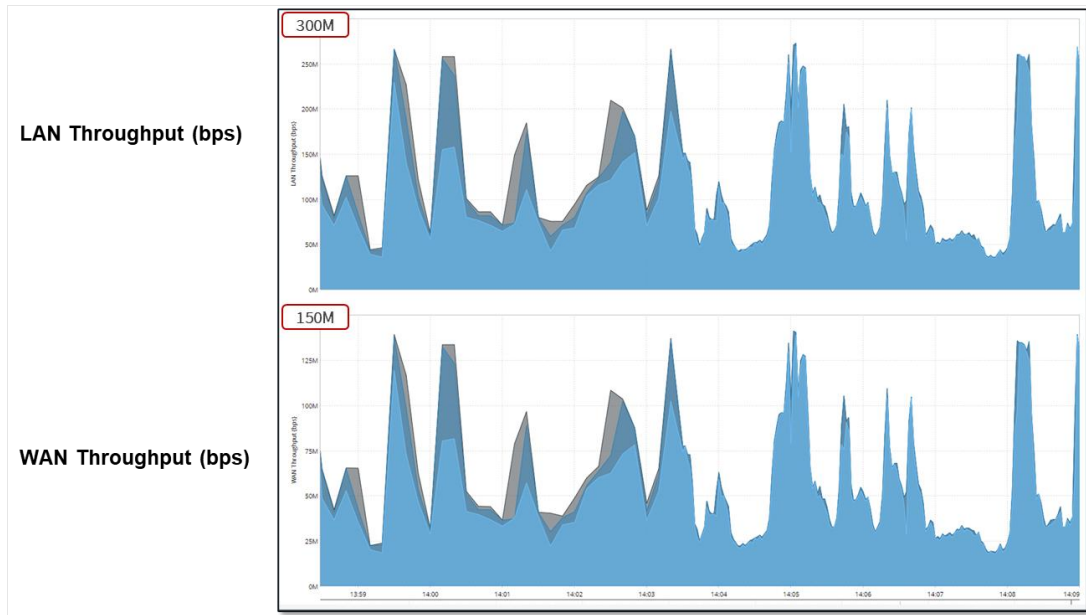

Source: Enterprise Strategy Group, a division of TechTarget, Inc.

ESG then evaluated the test results obtained when transferring both a compressible and uncompressible 700MB file through the Riverbed Acceleration solution, with a goal of observing the effects on file transfer time. We specifically paid attention to cold and warm (or hot) transfers.

- *Cold transfer*: The file was transmitted through the SteelConnect EX and SteelHead appliances for the first time. The data was compressible and stored on both SteelHead appliances.
- *Hot/warm transfer*: The same file was transmitted for the second time and the data was read either from memory (hot) or from the disk/SSD (warm).

File transfer times were recorded for the following scenarios:

- File transfer through the SteelConnect EX only.
- File transfer through both SteelConnect EX and SteelHead appliances, no Acceleration enabled.
- Cold transfer of uncompressible file through the SteelConnect EX and SteelHead appliances, Acceleration enabled.
- Cold transfer of compressible file through both the SteelConnect EX and SteelHead appliances, Acceleration enabled.
- Warm transfer of compressible file through both the SteelConnect EX and SteelHead appliances, Acceleration enabled.

We should note that the first two scenarios were run to baseline file transfer times of an uncompressible file when passing through the SteelHead appliances to show the effects of expected overhead, regardless of enabling Acceleration optimization. Results are displayed in Figure 4.

Figure 4. Branch-to-cloud Case: File Transfer Times over SD-WAN link with and without Acceleration

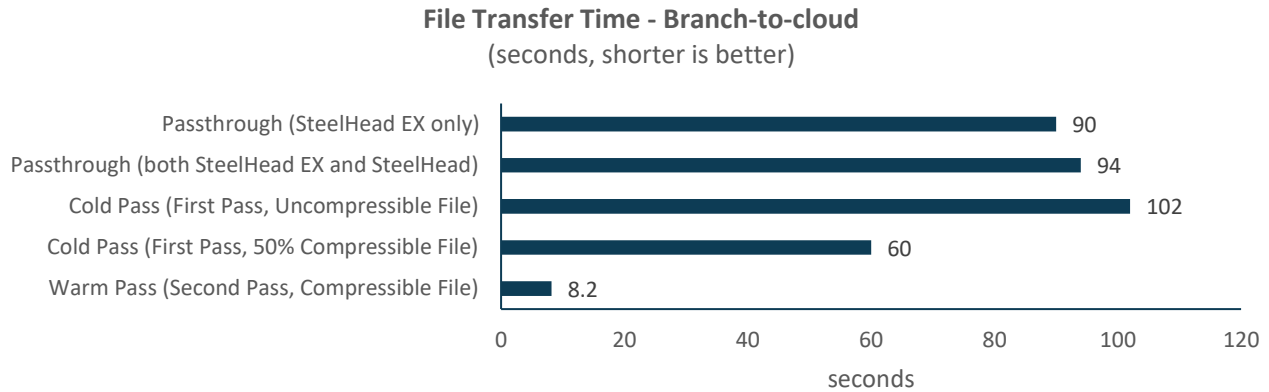

Source: Enterprise Strategy Group, a division of TechTarget, Inc.

What the Numbers Mean

- Overall, file transfer time decreased by 91% using the Riverbed Acceleration solution when compared to using SteelHead SD-WAN only.
- Compared to the scenarios in which Acceleration was not present, Enterprise Strategy Group (ESG) found that the file transfer of the cold first pass of the uncompressible file was slightly higher than the passthrough scenario. This was due to some overhead imposed by the SteelHead appliance.
- When downloading the 50% compressible file for the first time, ESG observed that file transfer time was lower than the cold transfer of the uncompressible file by 41%. File transfer time decreased by 41%. We concluded that this decrease was due to enabling Acceleration.
- ESG then observed that the file transfer between the first and second cold pass of the compressible file decreased by 86%, again attributed to Acceleration.
- ESG also noted that the optimization provided by the SteelHead was independent of the direction of the transfer.

ESG then evaluated how transfer times could be affected by enabling MX-TCP on the SteelHead appliance. MX-TCP is a TCP congestion avoidance technology designed to maximize network throughput by “ignoring” the TCP congestion algorithm, thus transmitting up to the bandwidth configured on the appliance. This results in less throughput variability, previously displayed in Figure 3. We examined throughput achieved when uploading a 700MB uncompressible file (cold pass) to AWS under the following conditions:

- Via the SteelConnect EX only.
- Via the SteelConnect EX and SteelHead appliances, Acceleration enabled.
- Via the SteelConnect EX and SteelHead appliance with 1MB buffers, Acceleration enabled.
- Via the SteelConnect EX and SteelHead appliance with 1MB buffers, Acceleration and MX-TCP enabled.
- Via the SteelConnect EX and SteelHead appliance with 1MB buffers, Acceleration, MX-TCP, and Multicore Balancing enabled.

Results are displayed in Figure 5.

Figure 5. Branch-to-cloud Case: Cold Transfer of Uncompressible File with and without MX-TCP

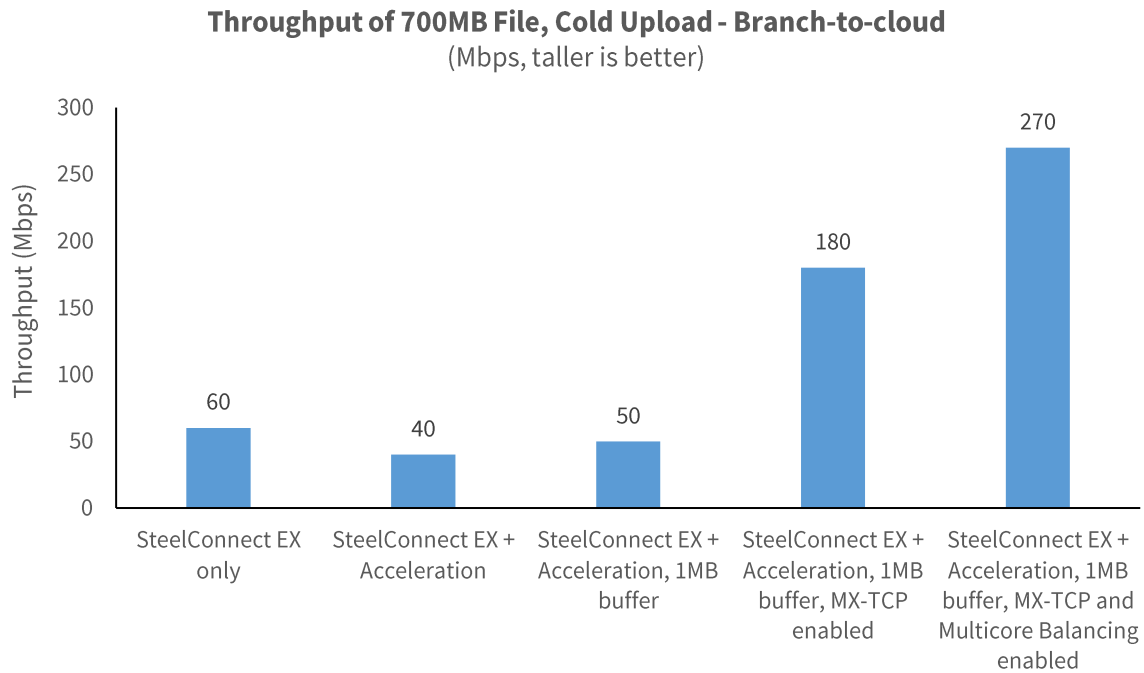

Source: Enterprise Strategy Group, a division of TechTarget, Inc.

What the Numbers Mean

- Enabling MX-TCP on the SteelHead appliance, with a 1MB buffer, resulted in a 360% increase in throughput compared to uploading the file via the Riverbed SD-WAN Acceleration solution with buffers alone (50 versus 180 Mbps).
- Enabling multicore balancing on the combined solution further boosted throughput by 150%. This shows the impact of multicore balancing on single file transfers.

i Why This Matters

Optimizing the employee experience is especially important, as more applications are migrating to the public cloud. Once an end user connects to the public cloud, applications may be located in a nearby availability zone, but the resources may be located anywhere within that zone, possibly introducing more network latency. Application performance is more likely to be variable and inconsistent over time as traffic traverses the public internet, which can contribute to a negative employee experience.

Enterprise Strategy Group’s (ESG’s) evaluation of performance test results related to file transfers with the Riverbed SD-WAN Acceleration solution over branch-to-cloud SD-WAN connections revealed accelerated application performance. We found that the combination of Riverbed SteelConnect EX and Acceleration can boost transfer times of compressible files by up to 86%.

Branch-to-branch Use Case

To evaluate the increase in performance that can be achieved with Riverbed SD-WAN Acceleration in SD-WAN links connecting branch offices, Enterprise Strategy Group (ESG) evaluated performance test results showing the application acceleration achieved when downloading large (2GB) files from an http server.



Enterprise Strategy Group (ESG) Testing

ESG used a testbed located in the Riverbed R&D Lab that simulated two branch offices, connected via an SD-WAN link. For the client side, we employed the single-box compatibility mode using the SteelConnect EX6080 with uCPE and a virtual SteelHead VCX70 (v9.12.1). For the server side, we employed the dual-box compatibility mode with a SteelConnect EX6080 (v21.2.2) and SteelHead CX7080 (v9.12.1). A Netropy WAN emulator connected the two branch offices. (Please refer to the *Appendix* for the testbed diagram.)

Traffic between the client and server side was generated with two Linux clients. To simulate the download, a 2GB file was transferred using the “*wget*” command. Both non-LZ compressible files (containing random data) and LZ-compressible files were used.

For these tests, we tuned the SteelHead WAN socket buffers according to the Bandwidth Delay Product (BDP), accounting for the contribution of both available network bandwidth and the delay inherent in the network transport. By tuning the socket buffers according to the BDP, an upper limit of performance to support efficient network transfer was imposed. In these tests, for a network delay of 160ms RTT, the WAN socket buffer size was set at 10MB.

ESG first compared file transfer times of a 2GB file under the test conditions of unrestricted bandwidth conditions on the network link (e.g., 10Gbps) and a network delay of 160 milliseconds (e.g., transmitting between the US and Europe). Times were recorded for the following scenarios:

- File transfer through SteelConnect EX only.
- File transfer through SteelConnect EX only with adjusted client buffers.
- Cold transfer of uncompressible file through the SteelConnect EX and SteelHead appliances, Acceleration enabled.
- Cold transfer of compressible file through the SteelConnect EX and SteelHead appliances, Acceleration enabled.
- Hot transfer of uncompressible file through the SteelConnect EX and SteelHead appliances, Acceleration enabled.

As in the previous testing, the first two scenarios were run to baseline file transfer times of an uncompressible 2GB file when passing through the SteelHead appliances to show the effects of expected overhead, regardless of whether Acceleration was enabled.

For these test runs, multicore balancing was enabled. When enabling this feature on a SteelHead appliance, every connection/flow is serviced by a single worker thread, while each thread is pinned to a single CPU core. Multicore balancing should be used if the throughput of an individual connection can exceed what the CPU can manage in order to avoid network bottlenecks. Ideally, multicore balancing should only be used when requiring high throughput on a single connection, such as single file transfers at higher speeds.

Results are displayed in Figure 6.

Figure 6. Branch-to-branch Case: File Transfer Times over SD-WAN link with and without Acceleration (Unrestricted Bandwidth)

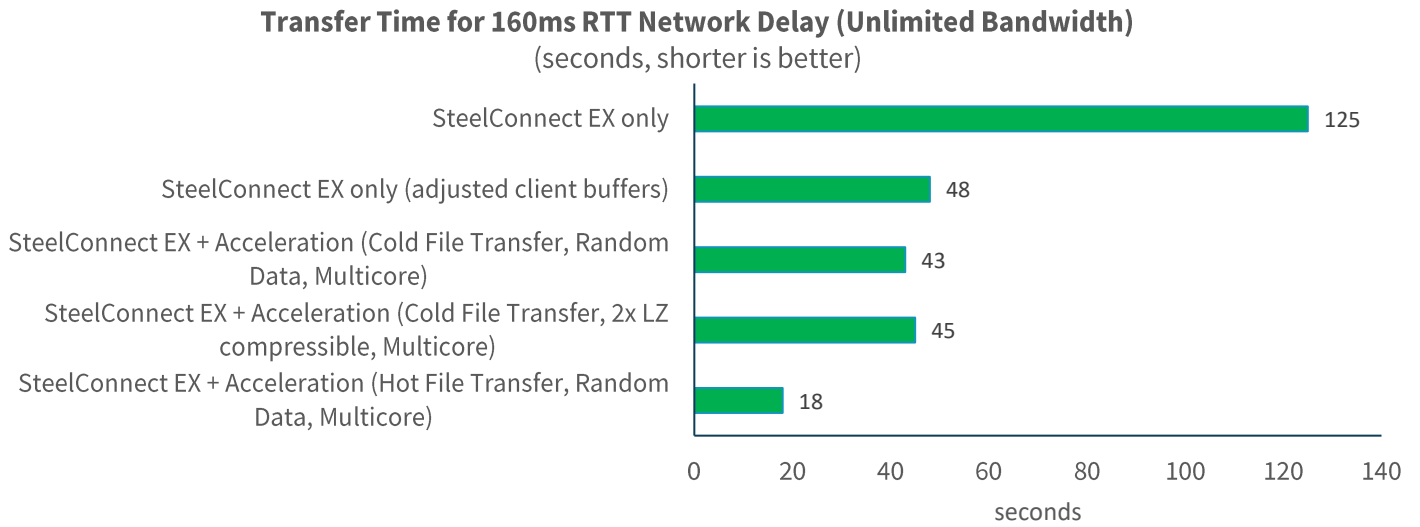

Source: Enterprise Strategy Group, a division of TechTarget, Inc.

What the Numbers Mean

- Overall, file transfer time decreased by 86% using the Riverbed SD-WAN Acceleration solution when compared to using SteelConnect EX only.
- A minor difference was observed when recording file transfer times in two scenarios: adjusting client buffers and increasing buffer size on the SteelHead appliance with Acceleration enabled (48 versus 43 seconds). However, adjusting the WAN socket buffers on the SteelHead appliance is more operationally efficient than adjusting buffers of multiple clients downloading data from the same file server.
- Compared to using the SteelConnect EX appliance only, Enterprise Strategy Group (ESG) found that file transfer times reduced between 64 - 86% once WAN optimization was enabled.
- For hot transfers of uncompressible data, ESG found that this achieved the lowest file transfer time across all scenarios. Compared to the cold transfer of the same file, transfer time decreased by 91%.

ESG then compared file transfer times of a 2GB file under the same conditions as the previous test, but with limited network bandwidth (i.e., 10Gbps) and a network delay of 160 milliseconds. Results are displayed in Figure 7.

Figure 7. Branch-to-branch Case: File Transfer Times over SD-WAN link with and without Acceleration (Limited Bandwidth)

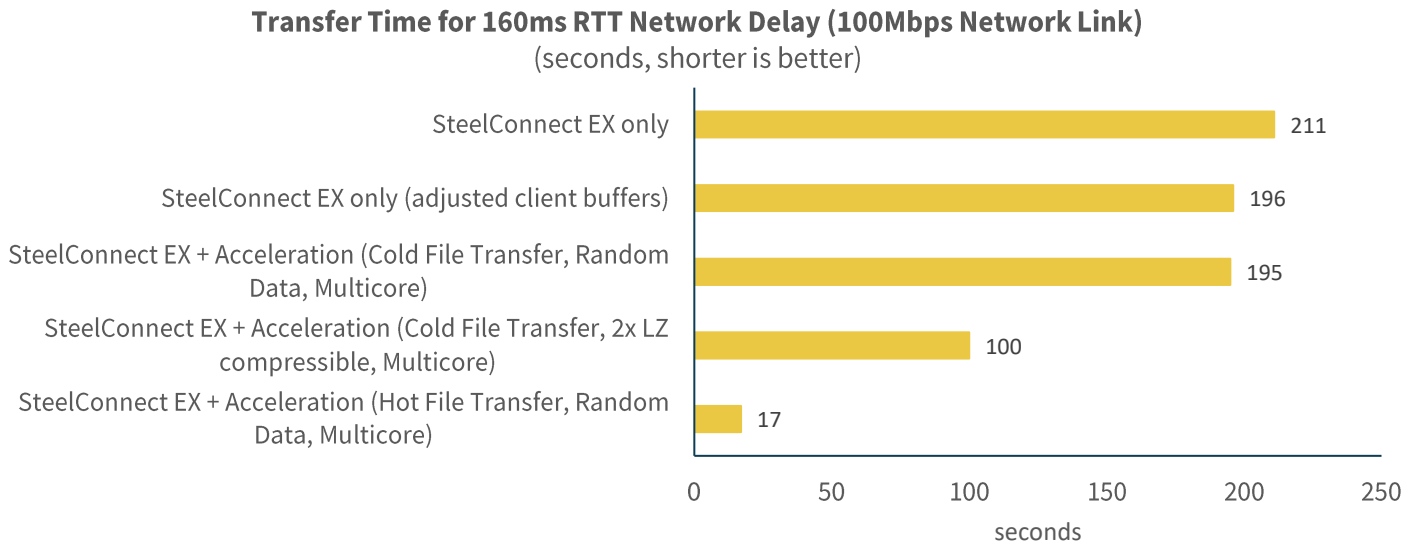

Source: Enterprise Strategy Group, a division of TechTarget, Inc.

What the Numbers Mean

- Overall, file transfer time decreased by 92% using the Riverbed SD-WAN Acceleration solution when compared to using SteelHead SD-WAN only.
- A minor difference was observed when recording file transfer times in two scenarios: adjusting client buffers and increasing buffer size on the SteelHead appliance with Acceleration enabled (196 versus 195 seconds). However, adjusting the WAN socket buffers on the SteelHead appliance is more operationally efficient than adjusting buffers of multiple clients downloading data from the same file server.
- After the initial cold transfer of the uncompressed file was completed, Enterprise Strategy Group (ESG) found that the file transfer time for the cold transfer of the compressed file decreased by 49%.
- After conducting the hot file transfer of the uncompressed file, transfer time decreased by 83% when compared to the cold transfer time of the compressed file.

i Why This Matters

As an organization’s branch locations become more dispersed within and across geographies, application performance remains a critical factor in maximizing operational efficiency. If applications are suffering from adequate performance, end users are unable to complete their jobs and fulfill business needs. Any delay experienced can easily translate into lost revenue or increased costs.

Enterprise Strategy Group’s (ESG’s) evaluation of performance test results related to the Riverbed SD-WAN Acceleration solution revealed that the combination of Riverbed SD-WAN and Acceleration can help to further accelerate application performance in a branch-to-branch case. We found that the combination of Riverbed SteelConnect EX and SteelHead Acceleration can boost transfer times of single compressed files by up to 83%.



The Bigger Truth

Organizations have been leveraging SD-WAN as part of their digital transformation initiatives in order to drive operational efficiencies that fulfill business needs with agility and speed. SD-WAN has decreased the time and manual effort for configuring and modifying IT networks, thus helping organizations to support changing business needs with speed and agility. However, as business needs change more rapidly, organizations must also optimize business application performance to ensure that end users can complete their work with minimal delay. SD-WAN, however, was not designed to accelerate application performance.

The Riverbed SD-WAN Acceleration solution combines Riverbed's SD-WAN product (SteelConnect EX) with the application acceleration capabilities of Riverbed's Acceleration, SteelHead, to accelerate application performance on SD-WAN links. This combined solution helps organizations to configure and maintain a highly available IT network while mitigating issues that are either related to the network (e.g., latency) or transport protocol (e.g., packet loss, network roundtrips) that can impede application performance.

Based on our evaluation of the results obtained by tests conducted in the Riverbed R&D Lab, Enterprise Strategy Group (ESG) validated that the Riverbed SD-WAN Acceleration solution can help boost application performance over SD-WAN connections. We observed that:

- Over SD-WAN links connecting branch offices to AWS, file transfer times can be reduced by up to 91% when Acceleration is enabled.
- Over SD-WAN links connecting branch offices to each other, file transfer times can be reduced by up to 86% when Acceleration is enabled.

SD-WAN has helped to increase network availability so that application downtime is minimized. Boosting application performance to overcome common network issues, such as latency and packet loss, is another way to help increase operational efficiency. If your organization wants to maximize its digital transformation efforts, it would be wise to consider the Riverbed SD-WAN Acceleration solution.

Appendix

Lab Diagram: Branch-to-cloud Use Case

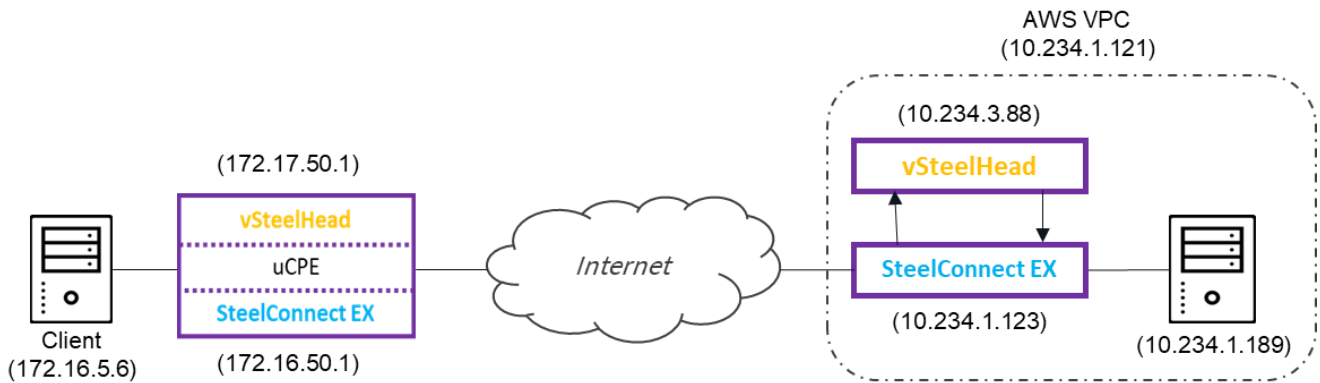

Source: Enterprise Strategy Group, a division of TechTarget, Inc.

Lab Diagram: Branch-to-branch Use Case

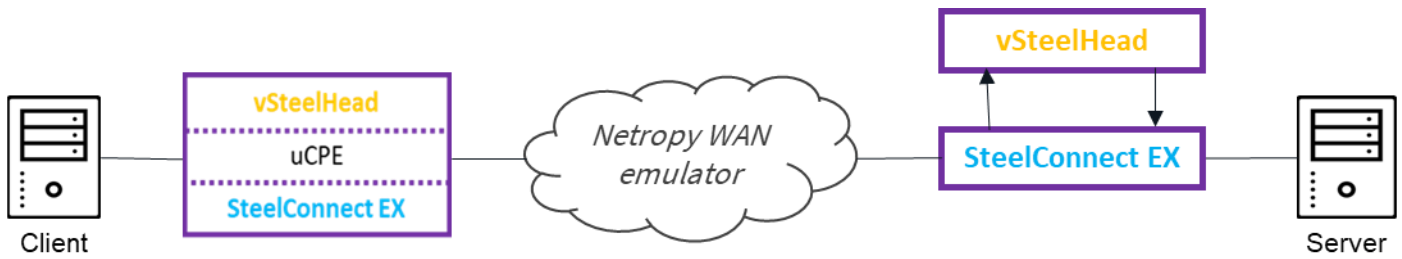

Source: Enterprise Strategy Group, a division of TechTarget, Inc.

All product names, logos, brands, and trademarks are the property of their respective owners. Information contained in this publication has been obtained by sources TechTarget, Inc. considers to be reliable but is not warranted by TechTarget, Inc. This publication may contain opinions of TechTarget, Inc., which are subject to change. This publication may include forecasts, projections, and other predictive statements that represent TechTarget, Inc.'s assumptions and expectations in light of currently available information. These forecasts are based on industry trends and involve variables and uncertainties. Consequently, TechTarget, Inc. makes no warranty as to the accuracy of specific forecasts, projections or predictive statements contained herein.

This publication is copyrighted by TechTarget, Inc. Any reproduction or redistribution of this publication, in whole or in part, whether in hard-copy format, electronically, or otherwise to persons not authorized to receive it, without the express consent of TechTarget, Inc., is in violation of U.S. copyright law and will be subject to an action for civil damages and, if applicable, criminal prosecution. Should you have any questions, please contact Client Relations at cr@esg-global.com.

The goal of Enterprise Strategy Group (ESG) Validation reports is to educate IT professionals about information technology solutions for companies of all types and sizes. ESG Validation reports are not meant to replace the evaluation process that should be conducted before making purchasing decisions, but rather to provide insight into these emerging technologies. Our objectives are to explore some of the more valuable features and functions of IT solutions, show how they can be used to solve real customer problems, and identify any areas needing improvement. The ESG Validation Team's expert third-party perspective is based on our own hands-on testing as well as on interviews with customers who use these products in production environments.



Enterprise Strategy Group is an integrated technology analysis, research, and strategy firm that provides market intelligence, actionable insight, and go-to-market content services to the global IT community.



www.esg-global.com



contact@esg-global.com



508.482.0188